

PADLOCK HASP

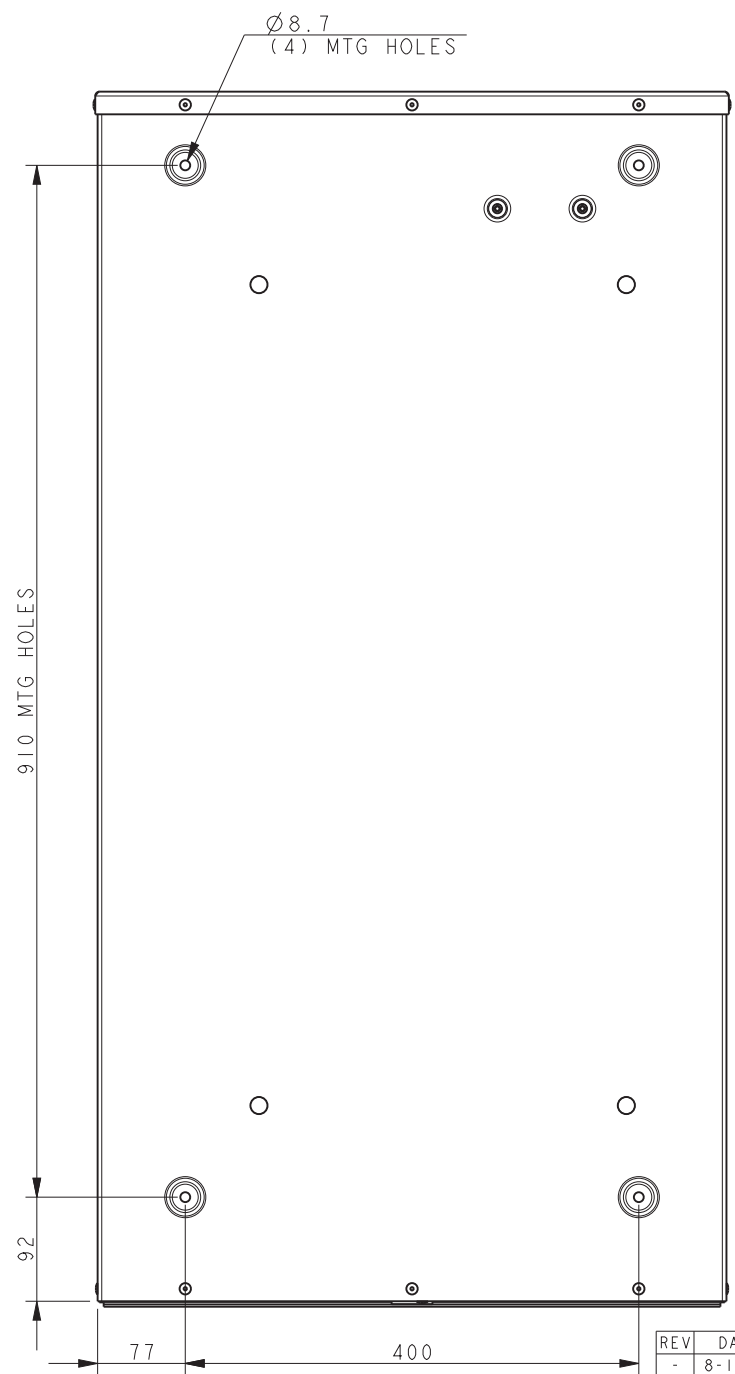
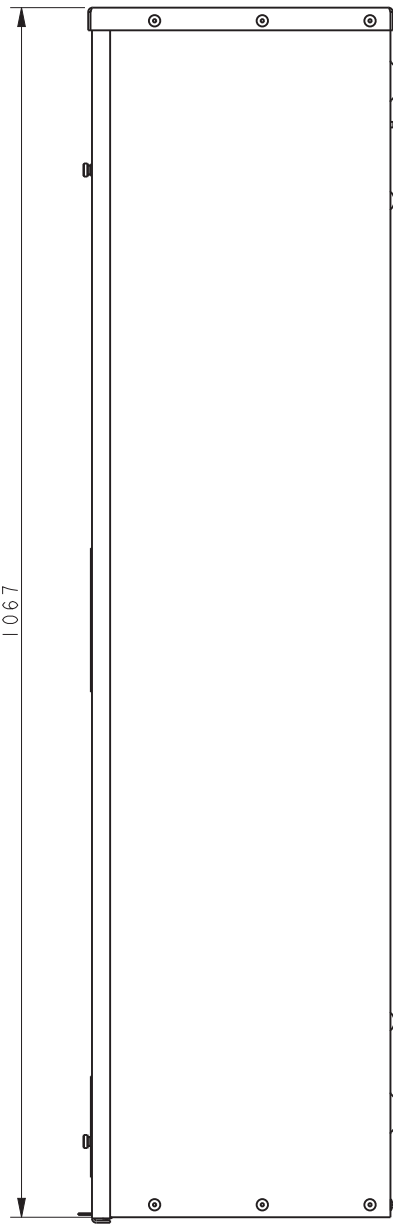
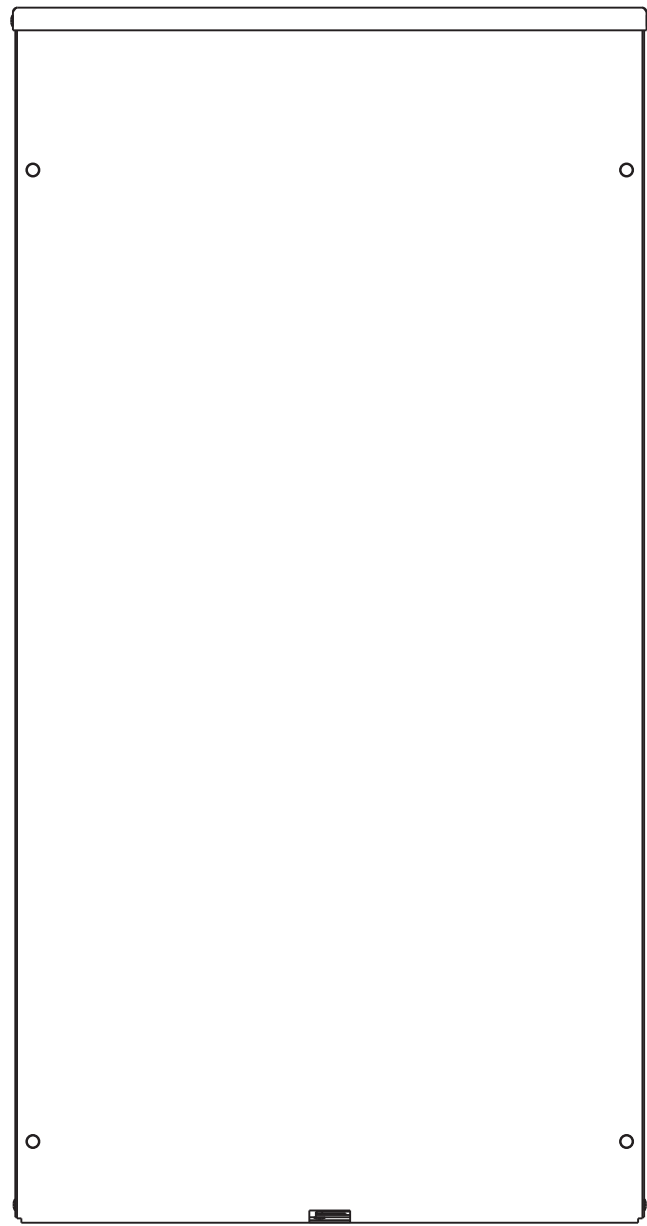

NOTES:  
 DIMENSIONS IN [ ] ARE INCHES.  
 FINISH: ANSI 49 GRAY.  
 REFER TO OPERATOR'S MANUAL PRIOR TO INSTALLATION AND OPERATION OF UNIT.  
 POWER CABLES AND CONTROL WIRING MUST BE RUN IN METAL CONDUIT  
 APPROXIMATE WEIGHT: 46 Kg (101 LBS.)  
 SERVICE DISCONNECT BREAKER IS 400A, 80% REATED. CONTINUOUS LOAD CURRENT IS NOT TO EXCEED 80% OF BREAKER RATING.

MODEL R  
 MPAC 500  
 400A 240V  
 SERVICE ENTRANCE  
 NEMA 3R

REV	DATE	ON COMPOSITE DWGS. SEE PART NO. FOR REVISION LEVEL	BY
-	8-17-11	NEW DRAWING [90714-4]	BTW
A	3-11-13	SEE SHEET 2 [CT40695]	BTW
B	7-16-13	SEE SHEET 2 [CT48126]	BTW
C	1-9-15	SEE SHEET 2 [CT103061]	BTW
D	1-12-18	SEE SHEET 2 [CT183231]	BTW
E	4-10-18	SEE SHEET 2 [CT186584]	RMJ

UNLESS OTHERWISE SPECIFIED -  
 1) DIMENSIONS ARE IN MILLIMETERS  
 2) TOLERANCES ARE:  
 X.XX ± 0.25  
 X.X ± 1.0  
 X ± 1.5  
 ANGLES ± 0° 30' MAX.

**KOHLER CO. METRIC PRO-E**  
 POWER SYSTEMS, KOHLER, WI 53044 U.S.A.  
 THIS DRAWING IN DESIGN AND DETAIL IS KOHLER CO. PROPERTY AND MUST NOT BE USED EXCEPT IN CONNECTION WITH KOHLER CO. WORK. ALL RIGHTS OF DESIGN OR INVENTION ARE RESERVED.

TITLE: **DIMENSION PRINT**

SCALE: 0.30 CAD NO. SHEET 1 of 2  
 DWG NO. **ADV-8445** D

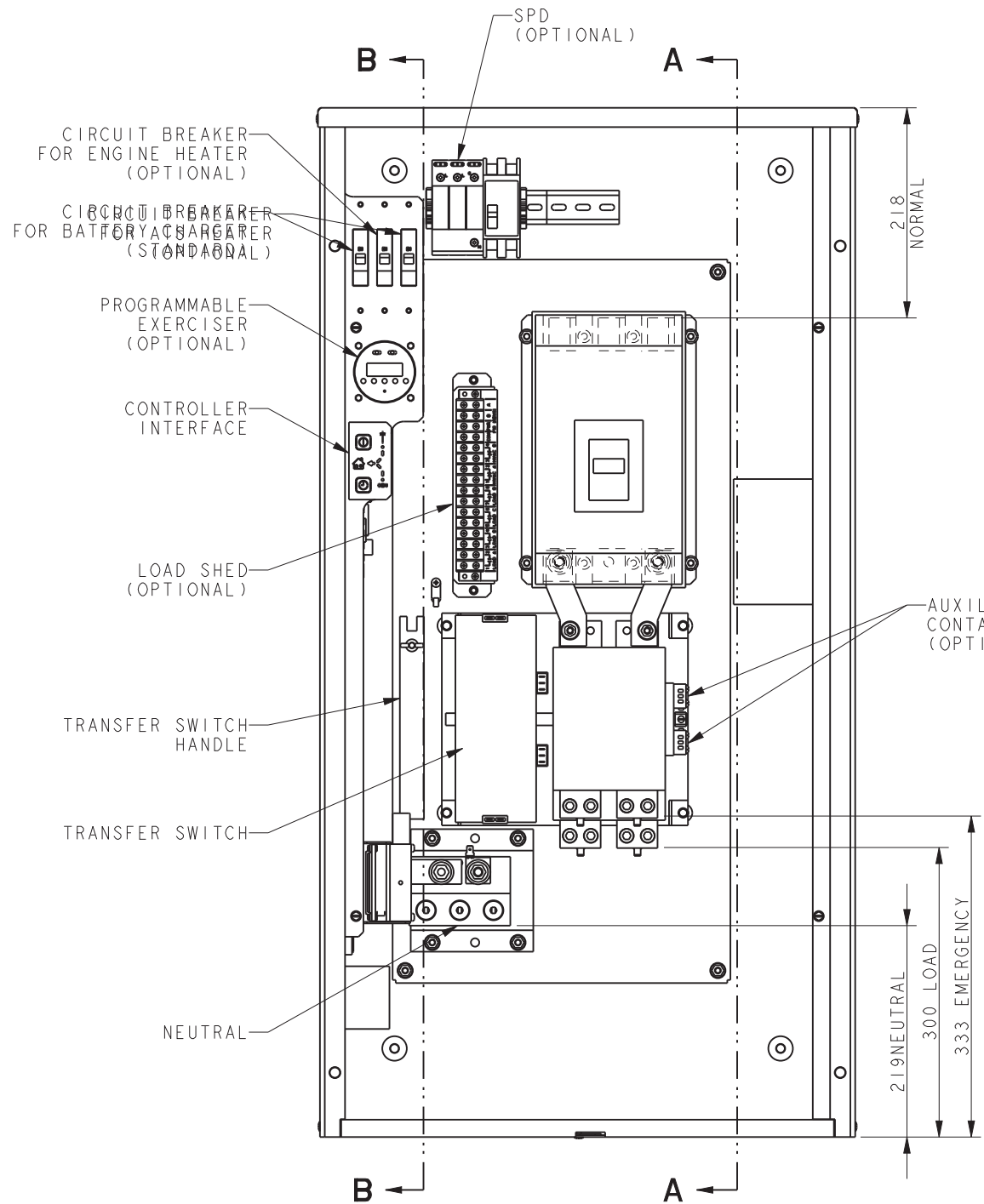

COVER & INNER PANEL REMOVED TO SHOW DETAIL

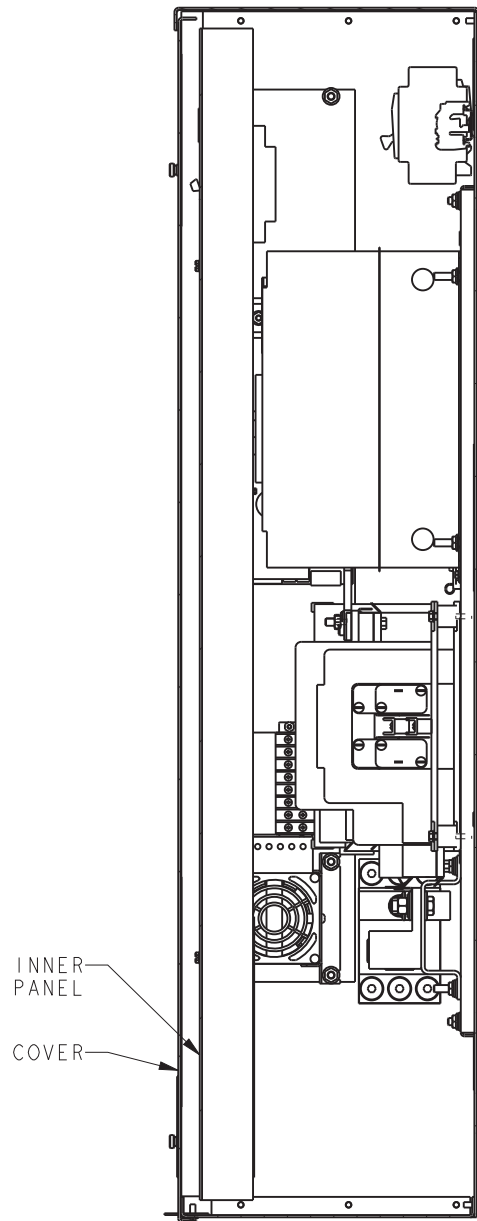

SECTION A-A

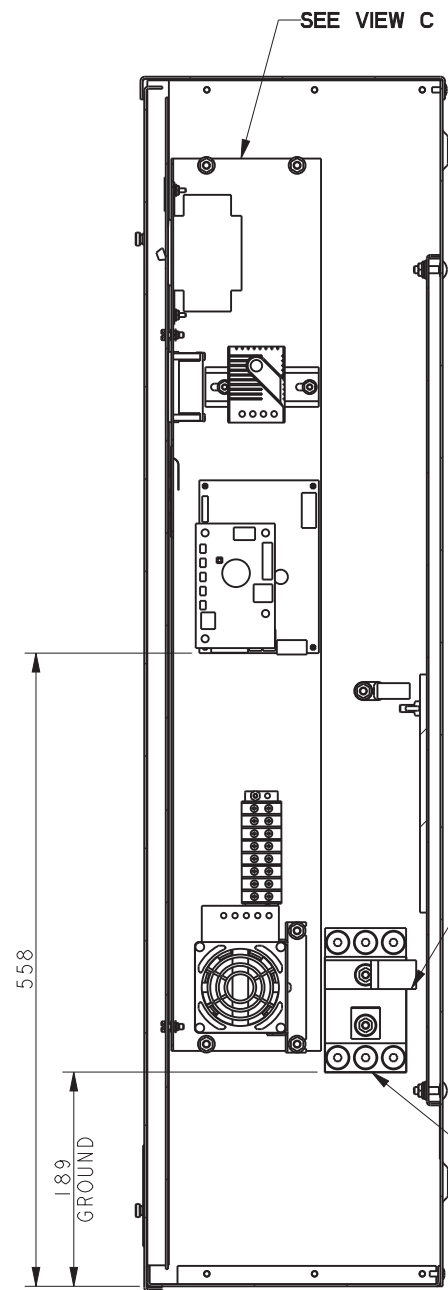

SECTION B-B

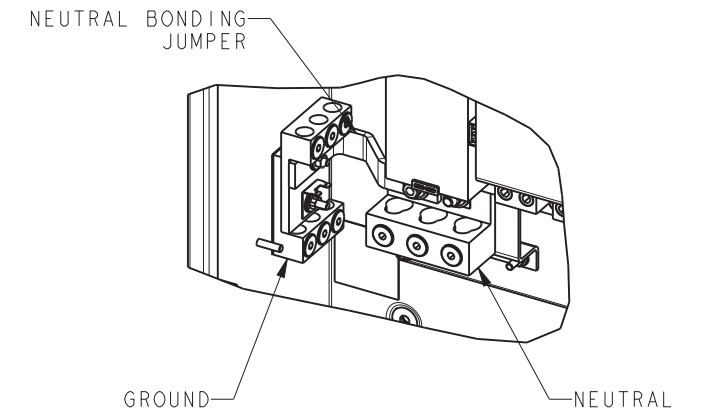

VIEW D

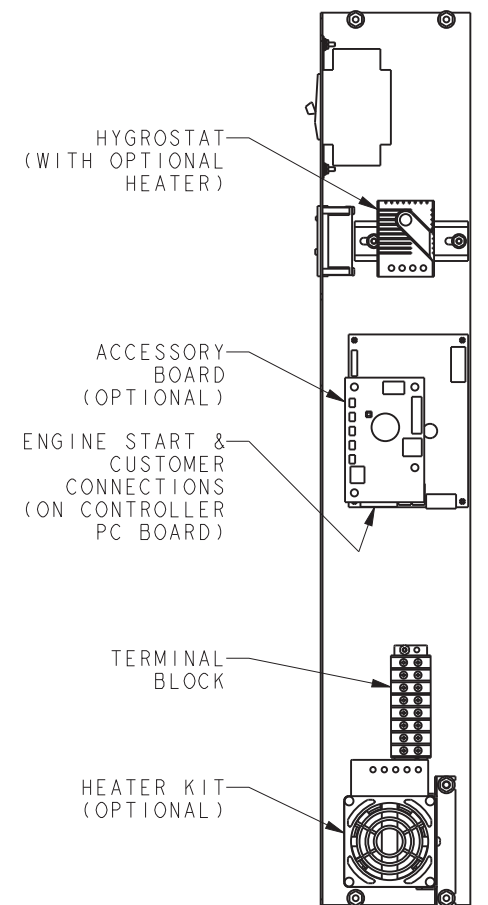

VIEW C

A: SCREW TYPE TERMINALS FOR EXTERNAL POWER CONNECTION

RANGE OF AL-CU WIRE SIZES

SWITCH RATING (AMPS)	RANGE OF AL-CU WIRE SIZES			
	NORMAL (PER PHASE)	EMERGENCY & LOAD (PER PHASE)	NEUTRAL	GROUND
400	(2) 1 AWG TO 250 KCMIL (1) 1 AWG TO 600 KCMIL	(2) #6 TO 250 KCMIL	(6) 1/0 TO 250 KCMIL (3) 4 TO 600 KCMIL	(6) #6 TO 3/0 AWG
TORQUE	375 lbf-in (42.4 Nm)	275 lbf-in (31.1 Nm)	UP TO 250 KCMIL 275 lbf-in (31.1 Nm) 300 KCMIL TO 600 KCMIL 500 lbf-in (56.5 Nm)	275 lbf-in (31.1 Nm)

MODEL R  
MPAC 500  
400A 240V  
SERVICE ENTRANCE  
NEMA 3R

REV	DATE	ON COMPOSITE DWGS. SEE PART NO. FOR REVISION LEVEL	BY	UNLESS OTHERWISE SPECIFIED - 1) DIMENSIONS ARE IN MILLIMETERS 2) TOLERANCES ARE:	TITLE
A	3-11-13	(A-8, -6) POWER CONNECTION CHART UPDATED; [CT40695]	BTW	X.XX ± 0.25 X.X ± 1.0 X ± 1.5	<b>KOHLER CO. METRIC PRO-E</b> POWER SYSTEMS, KOHLER, WI 53044 U.S.A. THIS DRAWING IN DESIGN AND DETAIL IS KOHLER CO. PROPERTY AND MUST NOT BE USED EXCEPT IN CONNECTION WITH KOHLER CO. WORK. ALL RIGHTS OF DESIGN OR INVENTION ARE RESERVED.
B	7-16-13	(C-7) LOAD SHED OPTION SHOWN; [CT48126]	BTW	ANGLES ± 0° 30' MAX.	
C	1-9-15	(A-7) (2) #6 TO 250 KCMIL WAS (2) 1/0 TO 250 KCMIL, (1) 4 TO 600 KCMIL REMOVED; (A-8) (1) 1 AWG TO 600 KCMIL ADDED, (2) 1 AWG TO 250 KCMIL WAS (2) 3/0 TO 250 KCMIL; [CT103061]	BTW	THIRD ANGLE PROJECTION	<b>DIMENSION PRINT</b> SCALE 0.30 CAD NO. SHEET 2 of 2 DWG NO.
D	1-12-18	(A-5) (6) #6 TO 3/0 AWG WAS (3) #6 TO 3/0 AWG; [CT183231]	BTW	APPROVALS DATE	<b>ADV-8445</b>
E	4-10-18	(A-8) TORQUE INFO ADDED TO TABLE [CT186584]	RMJ	CHECKED BTW 8-17-11 APPROVED MTL 8-17-11	