

BLUE STAR

Power Systems Inc.

Diesel Product Line

208-4160 Volt

MD1600-01

60 Hz / 1800 RPM

1600 kWe

Standby

Ratings

	208V	240V	480V	600V	4160V
Phase	3	3	3	3	3
PF	0.8	0.8	0.8	0.8	0.8
Hz	60	60	60	60	60
Generator Model	Consult Factory	Consult Factory	S7L1D-D	S7L1D-D	MWWI734H
Connection	4 LEAD WYE	4 LEAD DELTA	4 LEAD WYE	4 LEAD WYE	6 LEAD WYE
kWe	1600	1600	1600	1600	1600
AMPS	5558	4817	2408	1927	278
Temp Rise	Consult Factory	Consult Factory	125°C / 40°C	125°C / 40°C	125°C / 40°C

Standard Equipment

Engine

- Radiator Cooled Unit Mounted (50°C)
- Radiator Duct Flange (OPU Only)
- Blower Fan & Fan Drive
- Starter & Alternator
- Oil Pump & Filter
- Oil Drain Extension w/Valve
- Governor - Electronic Isochronous
- 24V Battery System & Cables
- Air Cleaner (Dry Single Stage)
- Critical Grade Silencer Mounted
- Flexible Fuel Connector
- EPA Certified Tier 2

Generator

- Brushless Single Bearing
- Automatic Voltage Regulator
- ± 0.50% Voltage Regulation
- 4 Pole, Rotating Field
- 125°C Standby Temperature Rise
- 100% of Rated Load - One Step
- 5% Maximum Harmonic Content
- NEMA MG 1, IEEE and ANSI Standards Compliance for Temperature Rise

Additional

- Single Source Supplier
- UL 2200 & cUL Listed through 600VAC
- CSA Certified through 600VAC
- Seismic Certified to IBC 2021
- NFPA 110 / CSA C282 Compliant
- Microprocessor Based Digital Control Panel Mounted in NEMA 12 Enclosure
- Base - Structural Steel
- Main Line Circuit Breaker Mounted & Wired
- Battery Charger 24V 5 Amp
- Jacket Water Heater (Qty 2) -20°F 9000W 240V w/Isolation Valves
- Vibration Isolation Mounts (Pad Type)
- 2 Year / 2000 Hour Standby Warranty
- Standard Colors - White / Gray

Application Data

Engine

Manufacturer:	Mitsubishi	Displacement - Cu. In. (lit):	3,989 (65.4)
Model:	S16R-Y2PTAW-1	Bore - in. (cm) x Stroke - in. (cm):	6.69 (17.0) x 7.09 (18.0)
Type:	4-Cycle	Compression Ratio:	14.5:1
Aspiration:	Turbo Charged, H2O/Air Intercooled	Rated RPM:	1800
Cylinder Arrangement:	16 Cylinder Vee	Max HP Stby (kWm):	2,346 (1,750)

Exhaust System

Standby

Gas Temp. (Stack): °F (°C)	940 (504)
Gas Volume at Stack Temp: CFM (m³/min)	15,642 (443)
Maximum Allowable Exhaust Restriction: in. H ₂ O (kPa)	23.6 (5.9)

Cooling System

Ambient Capacity of Radiator: °F (°C)	122 (50.0)
Maximum Allowable Static Pressure on Rad. Exhaust: in. H ₂ O (kPa)	0.50 (0.12)
Jacket Water Pump Flow Rate: GPM (lit/min)	489 (1,851)
Intercooler Pump Flow Rate: GPM (lit/min)	243 (920)
Heat Rejection to Jacket Coolant: BTUM (kW)	36,167 (633)
Heat Rejection to Intercooler: BTUM (kW)	36,167 (633)
Heat Radiated to Ambient: BTUM (kW)	31,609 (553)

Air Requirements

Aspirating: CFM (m³/min)	5,932 (168)
Air Flow Required for Rad. Cooled Unit: CFM (m³/min)	75,053 (2,124)
Air Flow Required for Heat Exchanger/Rem. Rad. CFM (m³/min)	Consult Factory For Remote Cooled Applications

Fuel Consumption

At 100% of Power Rating: gal/hr (lit/hr)	127 (481)
At 75% of Power Rating: ft ³ /hr (m ³ /hr)	96.0 (363)
At 50% of Power Rating: ft ³ /hr (m ³ /hr)	67.7 (256)

Fluids Capacity

Total Oil System: gal (lit)	60.8 (230)
Engine Jacket Water Capacity: gal (lit)	44.9 (170)
System Coolant Capacity: gal (lit)	174.4 (660)

Deration Factors: Rated Power is available up to 3280 ft (1000 m) at ambient temperatures to 104°F (40°C). Consult factory for site conditions above these parameters.

DCP7310 Control Panel

Standard Features

- Digital Metering
- Engine Parameters
- Generator Protection Functions
- Engine Protection
- CAN Bus (J1939) ECU Communications
- Windows-Based Software
- Multilingual Capability
- Remote Communications to DSE2548 Remote Annunciator
- 8 Programmable Contact Inputs
- 10 Contact Outputs
- RS485 Communicator Interface
- cULus Listed, CE Approved
- Event Recording
- IP 65 rating (with supplied gasket) offers increased resistance to water ingress
- NFPA 110 Level 1 Compatible

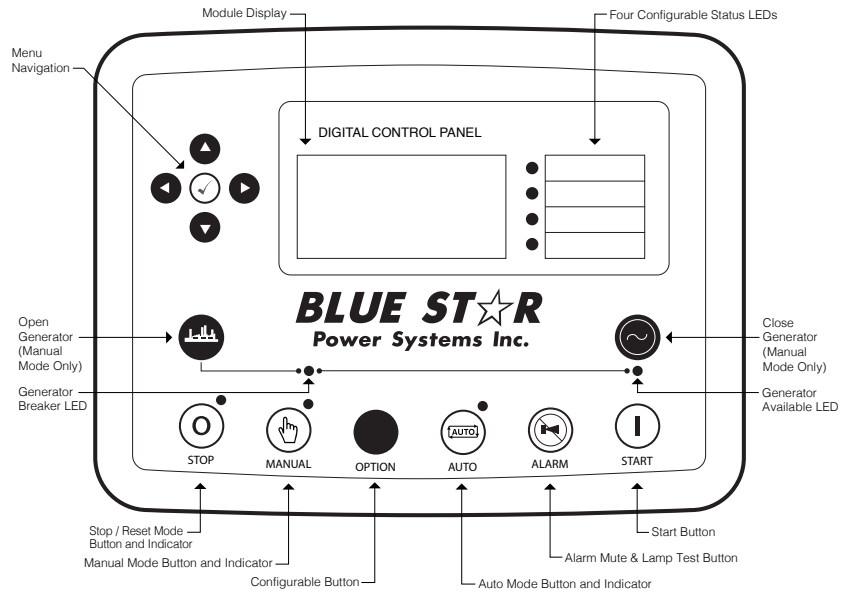

Weights / Dimensions / Sound Data

	L x W x H	Weight lbs
OPU	244 x 89 x 121 in	34,450
Level 1	282 x 110 x 145 in	39,850
Level 2	282 x 110 x 145 in	40,050
Level 3	378 x 110 x 145 in	42,475

Please allow 6-12 inches for height of exhaust stack.

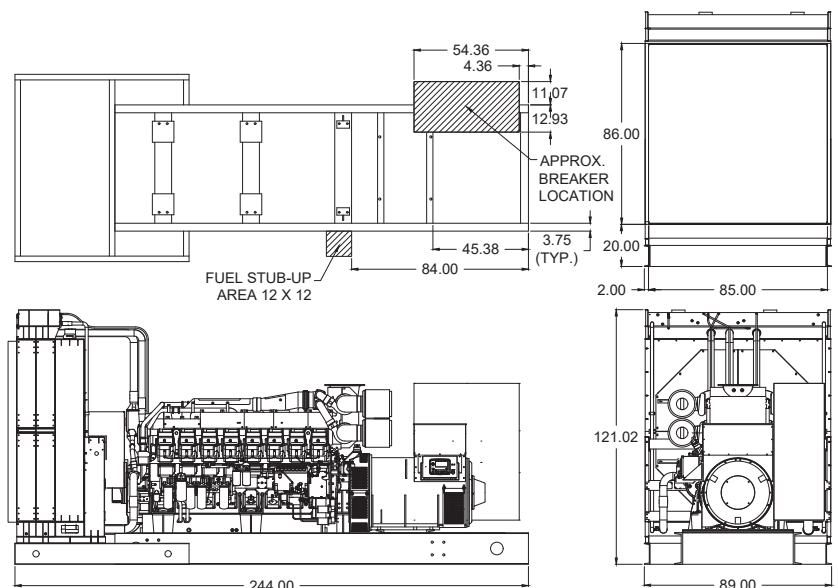

	No Load	Full Load
OPU	92 dBA	94 dBA
Level 1	85 dBA	87 dBA
Level 2	83 dBA	85 dBA
Level 3	80 dBA	82 dBA

Enclosures

Level 1 & 2 | Side View (Weather Proof)

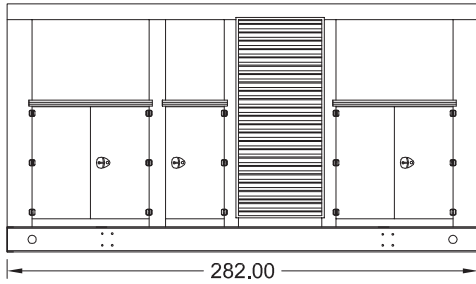

Level 3 | Side View (Sound Attenuated)

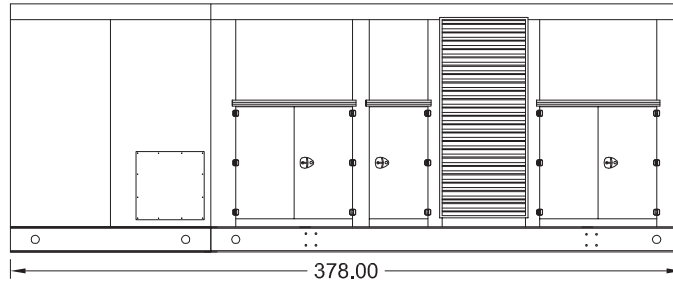

Level 1, 2 & 3 | Intake View

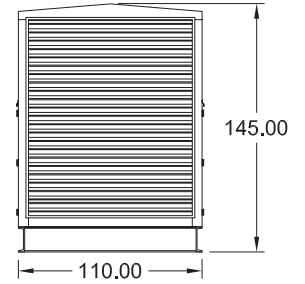

- All enclosure models are 200 MPH wind rating certified in accordance with IBC2021 and ASCE/SEI 7-16 standards.
- Level 2 & 3 enclosures include sound attenuation foam
- Level 3 enclosure includes frontal sound & exhaust hood.
- Enclosure height does not include exhaust stack.

Double Wall UL 142 Listed Fuel Tanks

OPU / Level 1 / Level 2

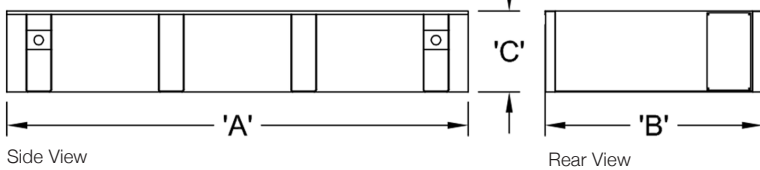

Side View

Rear View

Level 3

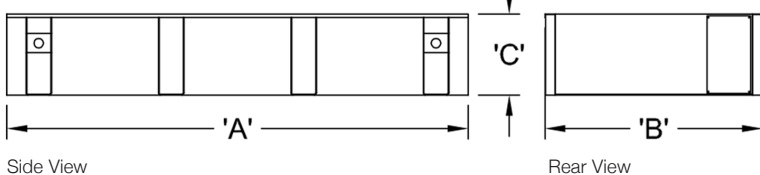

Side View

Rear View

	12 Hour 1925 Gallon	24 Hour 3850 Gallon	48 Hour 7700 Gallon
A	282.00	312.00	576.00
B	110.00	110.00	110.00
C	22.00	36.00	36.00
	12 Hour 1925 Gallon	24 Hour 3850 Gallon	48 Hour 7700 Gallon
A	378.00	378.00	576.00
B	110.00	110.00	110.00
C	16.00	28.00	36.00

Notes

- All specification sheet dimensions are represented in inches.
- All drawings based on standard 480 volt standby generator. Lengths may vary with other voltages. All drawings and dimensions subject to change without notice.
- All enclosures and fuel tanks are based on the standard unit configuration. Any requested deviation can change dimensions.
- Sound data is measured at 23 feet (7 meters) in accordance with ISO 8528-10.
- All materials and specifications subject to change without notice.

American Owned



American Made

Blue Star Power Systems, Inc.

2250 Carlson Drive

North Mankato, Minnesota 56003

Phone + 1 507 345 1776

bluestarps.com

quote.bluestarps.com

sales@bluestarps.com