

MOTEUR ENGINE	ALTERNATEUR ALTERNATOR	CHASSIS AVEC RESERVOIR GASOIL FRAME WITH FUEL TANK			
		MASSE / WEIGHT (kg / lbs) +/- 5%		COG (mm / inch)	
		A vide / Dry	OdM / Wet	CG Horizontal	CG Vertical
DOOSAN DP180LA	KH02713T	5628 / 12407	6332 / 13959	3281 / 129	910 / 36
	KH02954T	5710 / 12588	6414 / 14140	3270 / 129	908 / 36
	KH03546T	5936 / 13086	6641 / 14640	3230 / 127	902 / 36
DOOSAN DP180LB	KH02954T	5730 / 12632	6434 / 14181	3259 / 128	909 / 36
	KH02713T	5683 / 12528	6388 / 14083	3278 / 129	912 / 36
DOOSAN DP222LC	KH03546T	5956 / 13130	6661 / 14684	3220 / 127	903 / 36
	KH03546T	6300 / 13889	7037 / 15513	3282 / 129	1006 / 40
KOHLER KD18L6	KH03546T	6880 / 15157	7610 / 16779	2890 / 114	942 / 37
	KH02970T	7050 / 15541	7700 / 16971	2900 / 114	942 / 37
VOLVO TAD1641GE	KH01983T	5680 / 12518	6410 / 14137	2990 / 118	940 / 37
	KH02215T	5800 / 12778	6530 / 14397	3010 / 119	940 / 37
	KH02713T	5930 / 13083	6670 / 14702	3040 / 120	940 / 37
VOLVO TAD1642GE	KH02215T	5800 / 12778	6530 / 14397	3010 / 119	940 / 37
	KH02713T	5930 / 13083	6670 / 14702	3040 / 120	940 / 37
	KH02954T	6010 / 13259	6750 / 14878	3050 / 120	930 / 37

TABLEAU DES MASSES POUR CHASSIS SANS RESERVOIR, VOIR FOLIO 2/3
WEIGHT TABLE FOR FRAME WITHOUT TANK, SEE SHEET 2/3

- Voir folios suivants pour informations complémentaires / See following sheets for additional informations.
- Les noms des vues correspondent aux différentes faces du groupe électrogène / The names of the views correspond to the different sides of the generating set.

REV	DATE	ON COMMENTS (VUE, REV. PART NO. FOR REVISION LEVEL, DIMENSIONS THAT NUMBERS AFFECTED BY LATEST DRAWING REVISION)	BY	APPR	DATE
A	27FEB2023	NEW DRAWING	APM		
B	28SEP2023	DRAWING UPDATED	RSB		
		DRAWING CONFORM WITH 2023/09/28	SBH		

DO NOT SCALE. THIS ASSEMBLY OR PART MUST COMPLY WITH DIMENSIONS, DIMENSIONS AND TOLERANCES. UNLESS OTHERWISE SPECIFIED, DIMENSIONS ARE IN MILLIMETERS.

KOHLER

SCALE: 1:15 SHEET SIZE: A0 SHEET 1 OF 3

TITLE: PLANCHE -CP-EX4-M240-FRAME-WWO-TANK
REV. NO. 30001546501

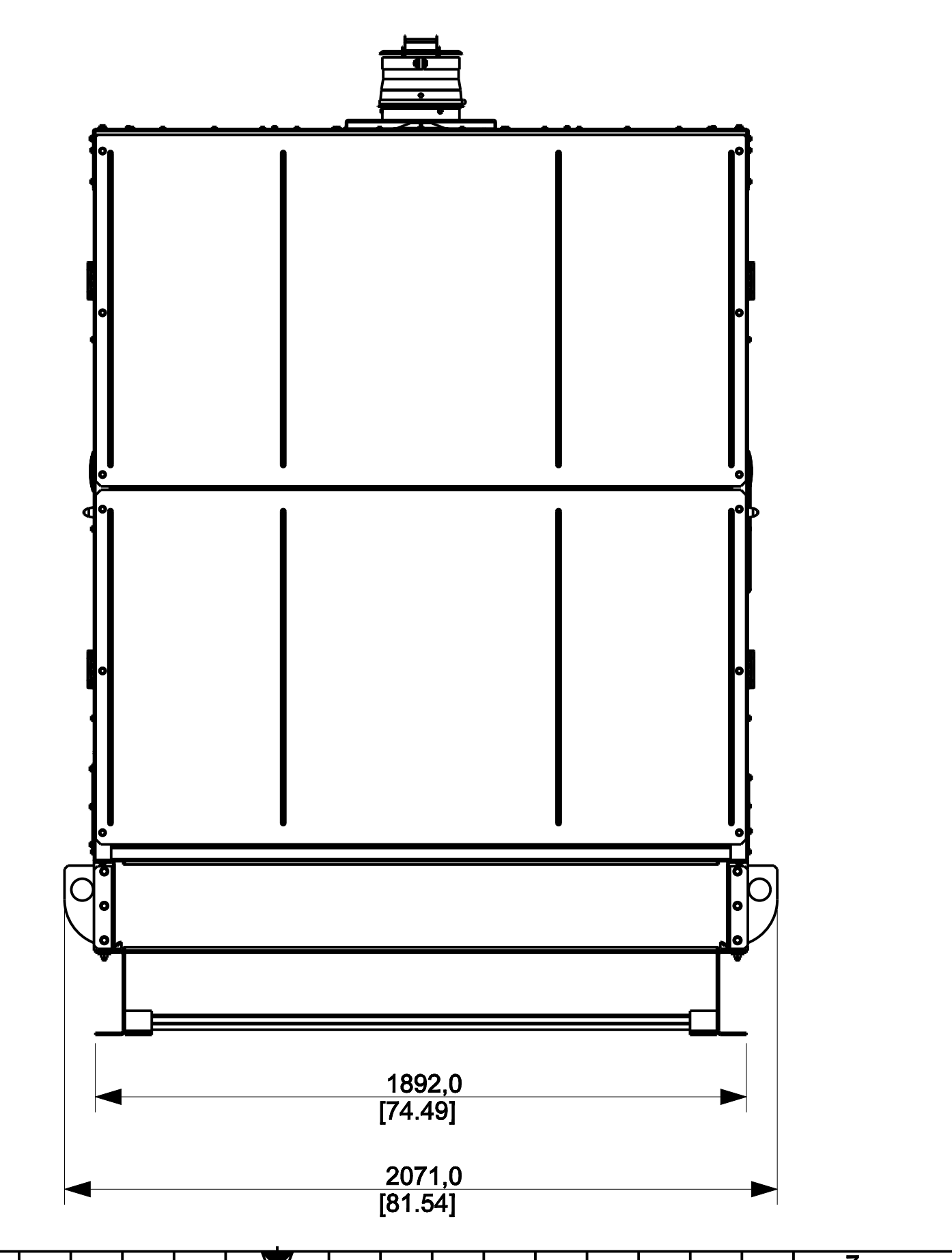
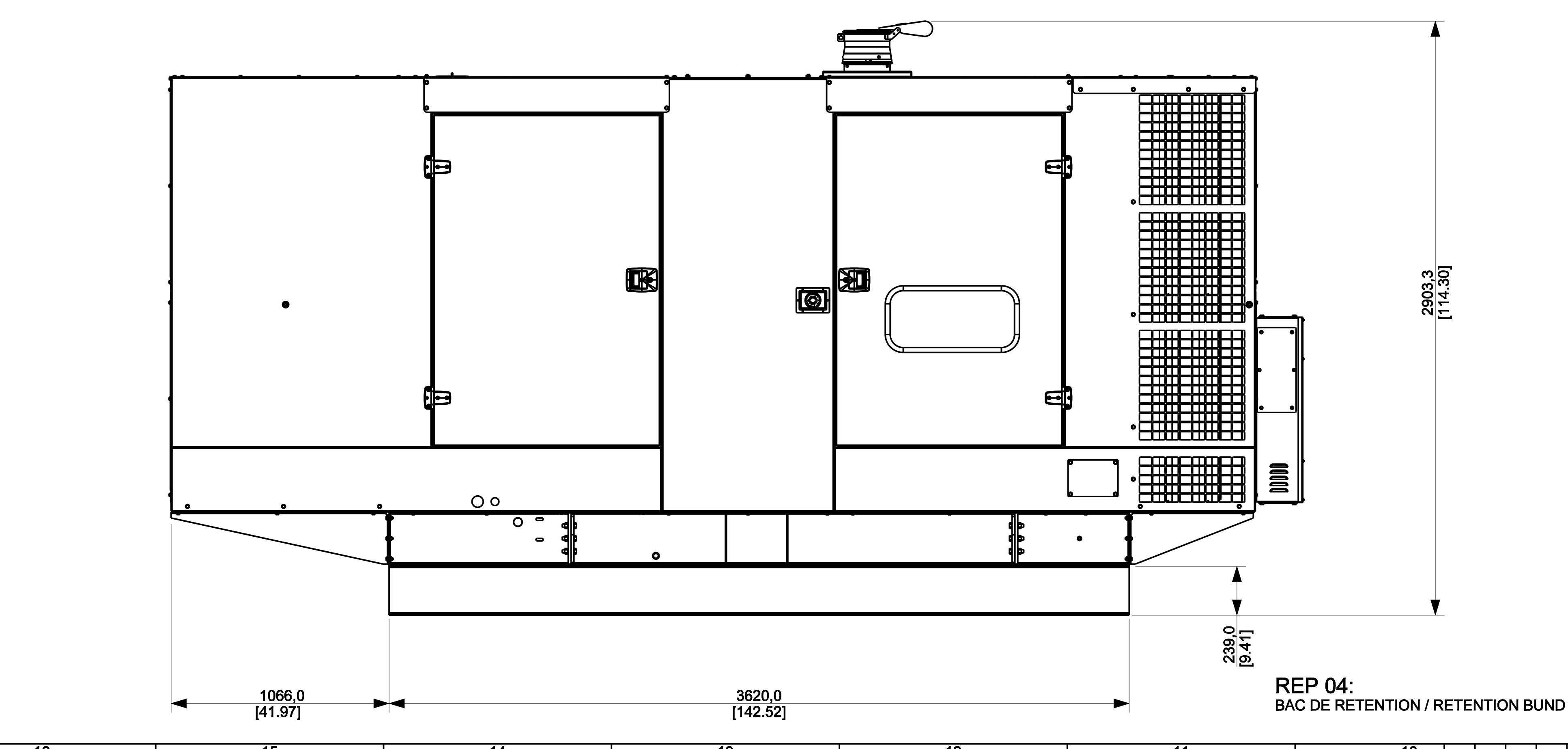
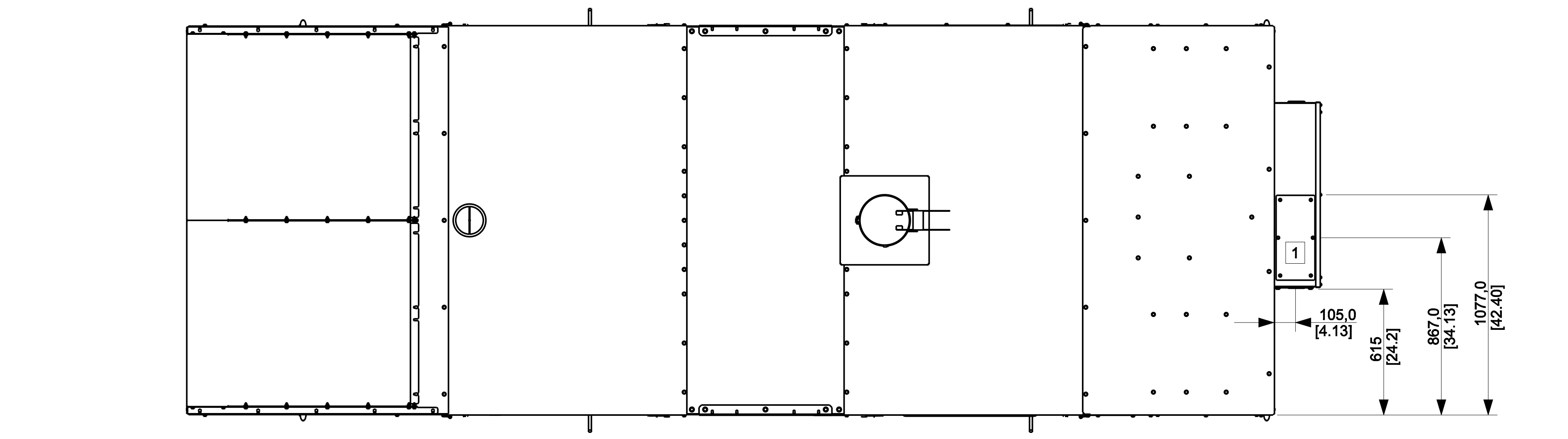
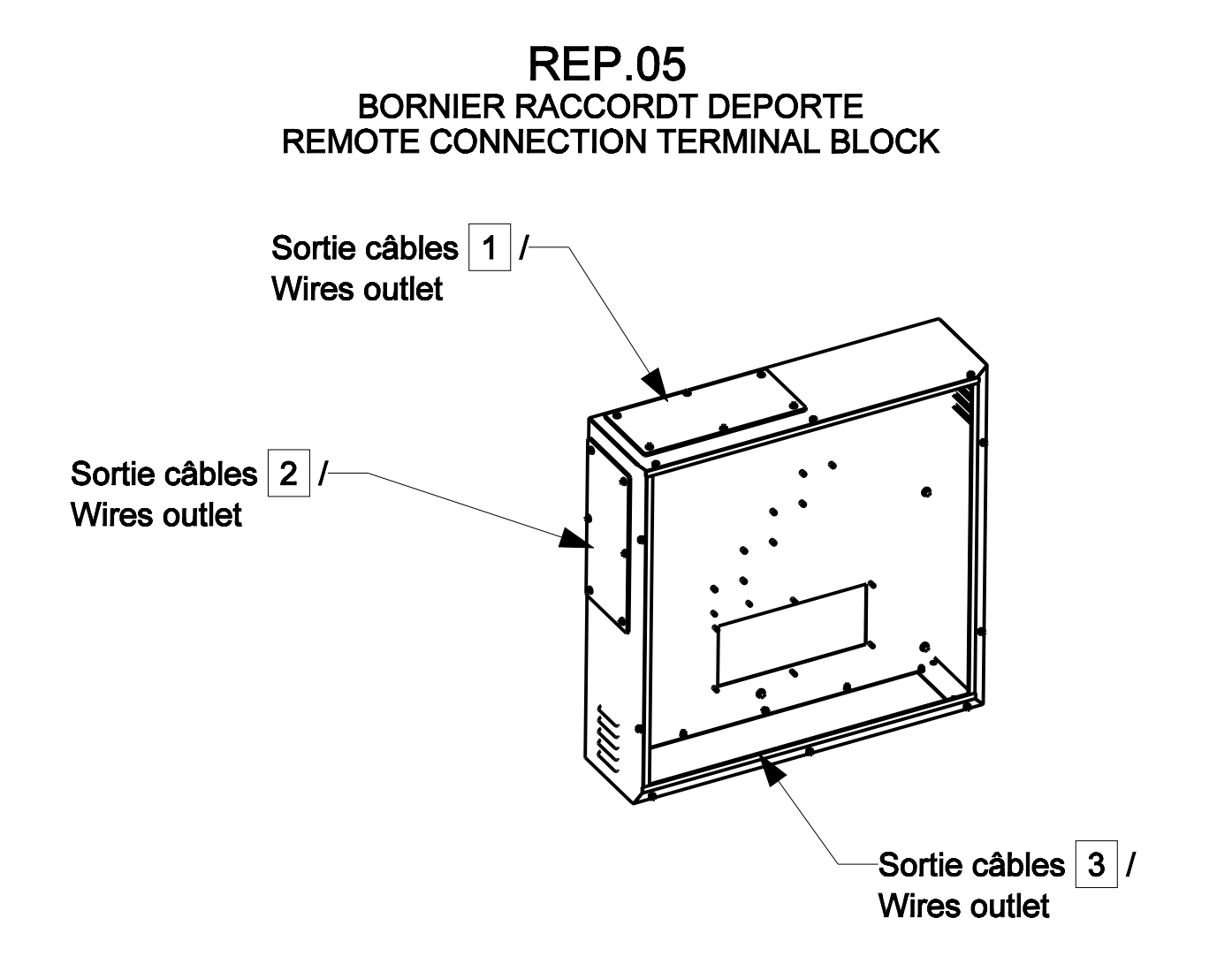
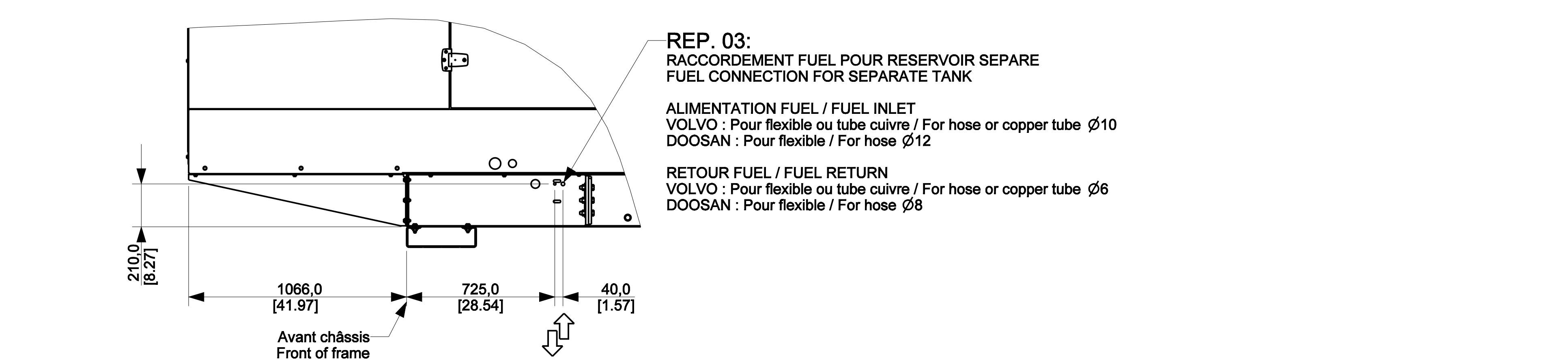
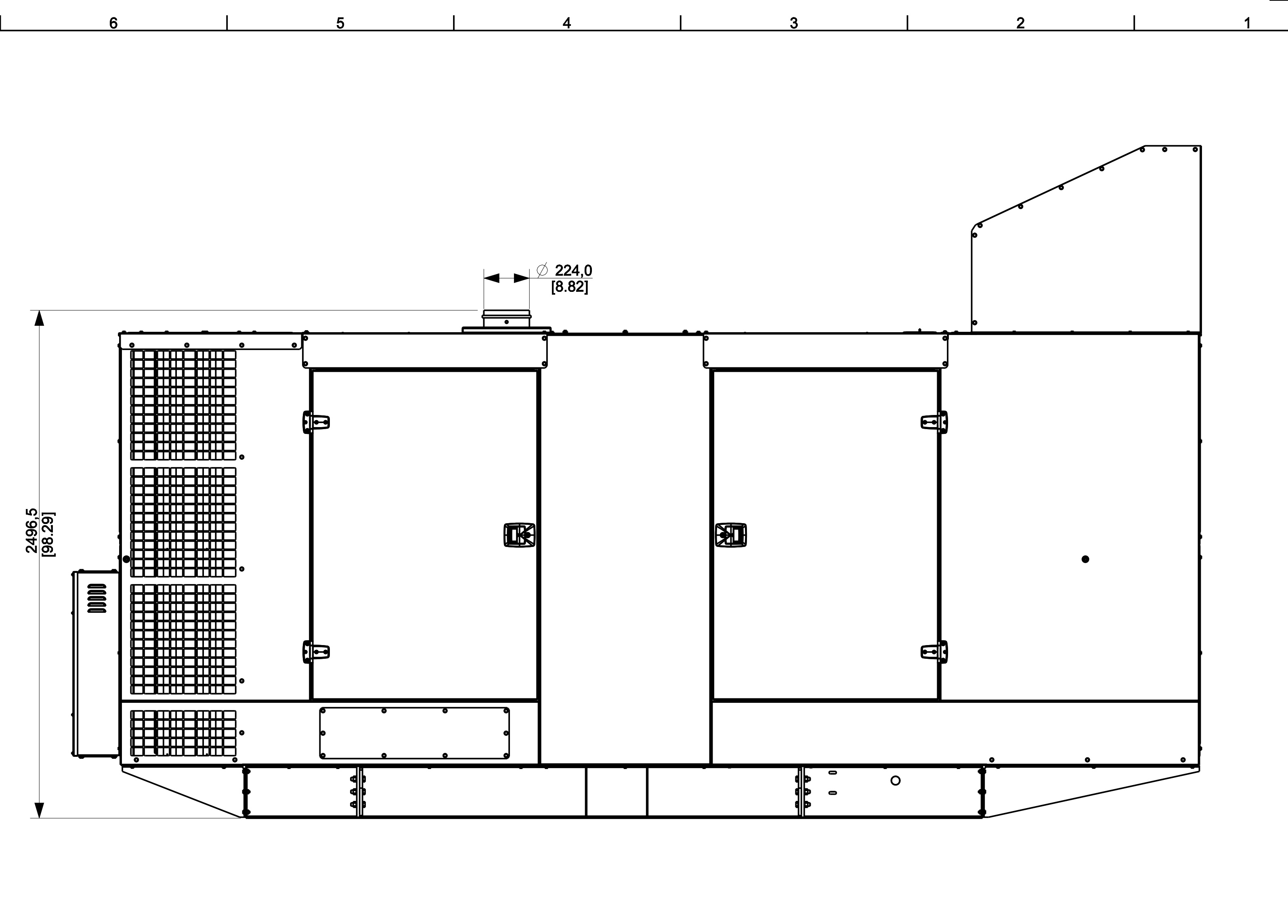
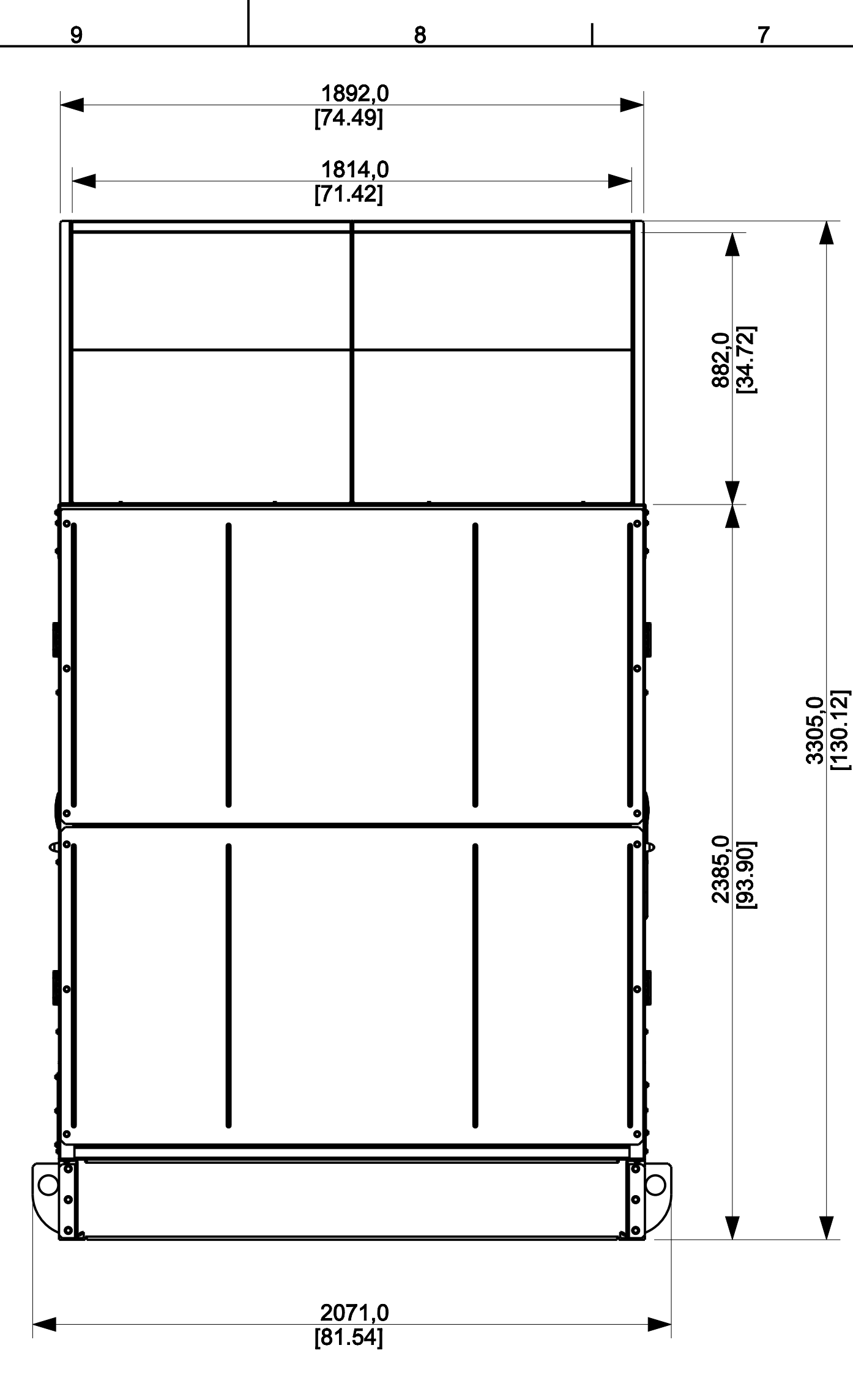
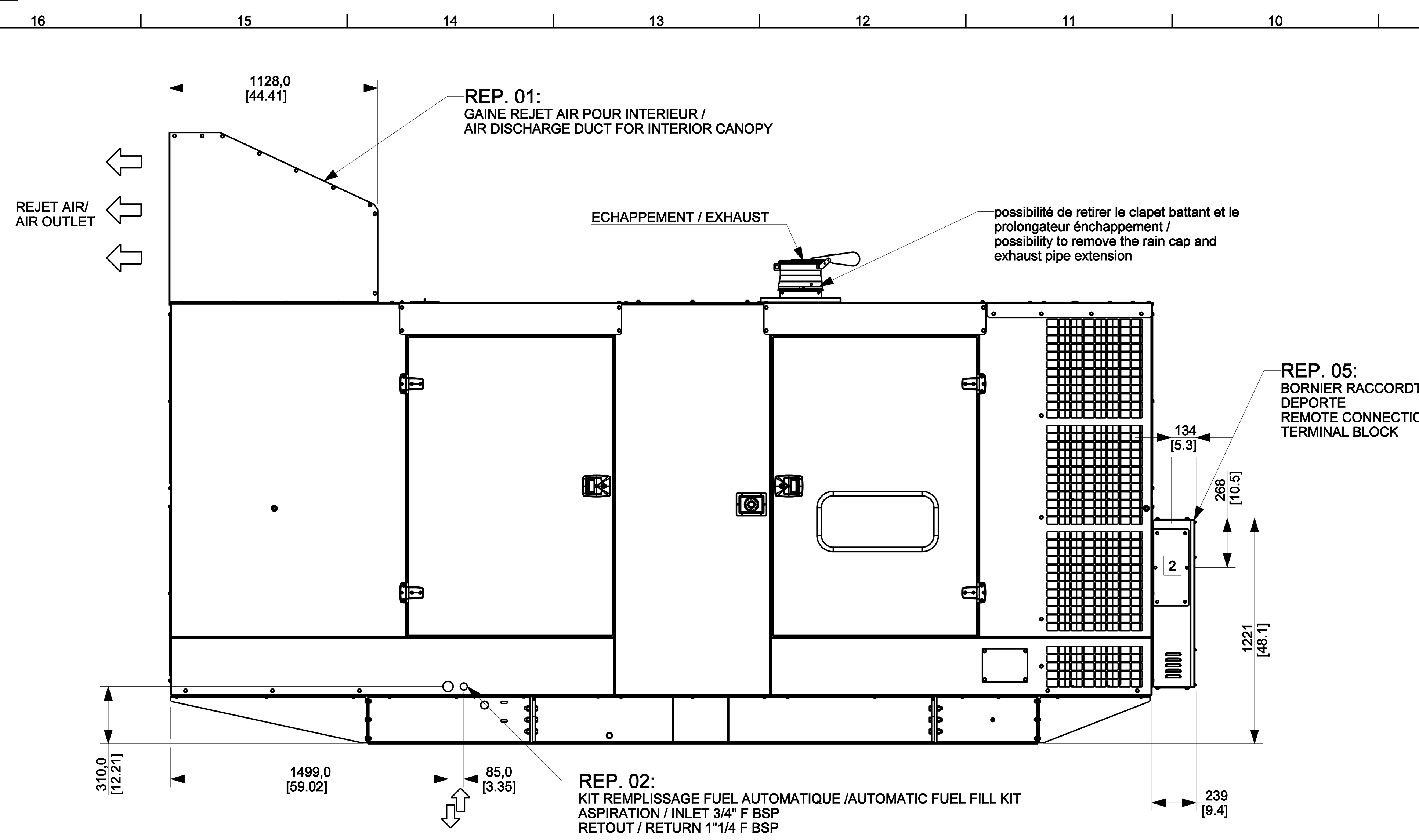

MOTEUR ENGINE	ALTERNATEUR ALTERNATOR	CHASSIS SANS RESERVOIR GASOIL FRAME WITHOUT FUEL TANK			
		MASSE / WEIGHT (kg / lbs) +/- 5%		COG (mm / inch)	
		A vide / Dry	OdM / Wet	CG Horizontal	CG Vertical
DOOSAN DP180LA	KH02713T	5134 / 11318	5280 / 11640	3262 / 128	1017 / 40
	KH02954T	5212 / 11490	5358 / 11812	3250 / 128	1013 / 40
	KH03546T	5699 / 12564	5852 / 12901	3206 / 126	1002 / 39
DOOSAN DP180LB	KH02954T	5231 / 11532	5377 / 11854	3238 / 127	1013 / 40
	KH02713T	5187 / 11435	5333 / 11757	3260 / 128	1017 / 40
	KH03546T	5719 / 12608	5872 / 12945	3194 / 126	1003 / 39
DOOSAN DP222LC	KH03546T	6036 / 13307	6222 / 13717	3293 / 130	1378 / 54
VOLVO TAD1641GE	KH01983T	5440 / 11988	5550 / 12228	2930 / 115	1070 / 42
	KH02215T	5560 / 12247	5660 / 12488	2960 / 116	1060 / 42
	KH02713T	5690 / 12553	5800 / 12793	2980 / 117	1060 / 42
VOLVO TAD1642GE	KH02215T	5560 / 12247	5660 / 12488	2960 / 116	1060 / 42
	KH02713T	5690 / 12553	5800 / 12793	2980 / 117	1060 / 42
	KH02954T	5770 / 12729	5880 / 12969	2990 / 118	1050 / 41

INFORMATIONS SUPPLEMENTAIRES ADDITIONAL INFORMATION	REP.
GAINÉ REJET AIR CAPOT INTERIEUR AIR DISCHARGE DUCT FOR INTERIOR CANOPY	01
KIT REMPLISSAGE FUEL AUTOMATIQUE AUTOMATIC FUEL FILL KIT	02
RACCORDEMENT FUEL SEPARÉ SUR CUV EXTERIEURE FUEL CONNECTION FOR SEPARATE TANK	03
BAC DE RETENTION RETENTION BUND	04
BORNIER RACCORDEMENT DEPORTE REMOTE CONNECTION TERMINAL BLOCK	05

REV	DATE	DESCRIPTION	BY	CHK	APP
A	21FEB2023	NEW DRAWING	APM		
B	27SEP2023	DRAWING UPDATED	RSB		
C	28SEP2023	DRAWING UPDATED	RSB		

DO NOT SCALE. THIS ASSEMBLY OR PART MUST COMPLY WITH DIMENSIONS FOR UNDESIGNATED DIMENSIONS.

KOHLER

SCALE: 1:15 SHEET SIZE: A0 SHEET: 2 OF 3

PLANT: CP-EX4-M240-FRAME-WWO-TANK

REV. NO. 30001548501

VERSION CHASSIS AVEC OU SANS RESERVOIR, SANS BAC DE RETENTION /
WITH OR WITHOUT TANK FRAME VERSION, WITHOUT RETENTION BUND

DIMENSIONS DE TRANSPORT /
OVERALL DIMENSIONS FOR TRANSPORT

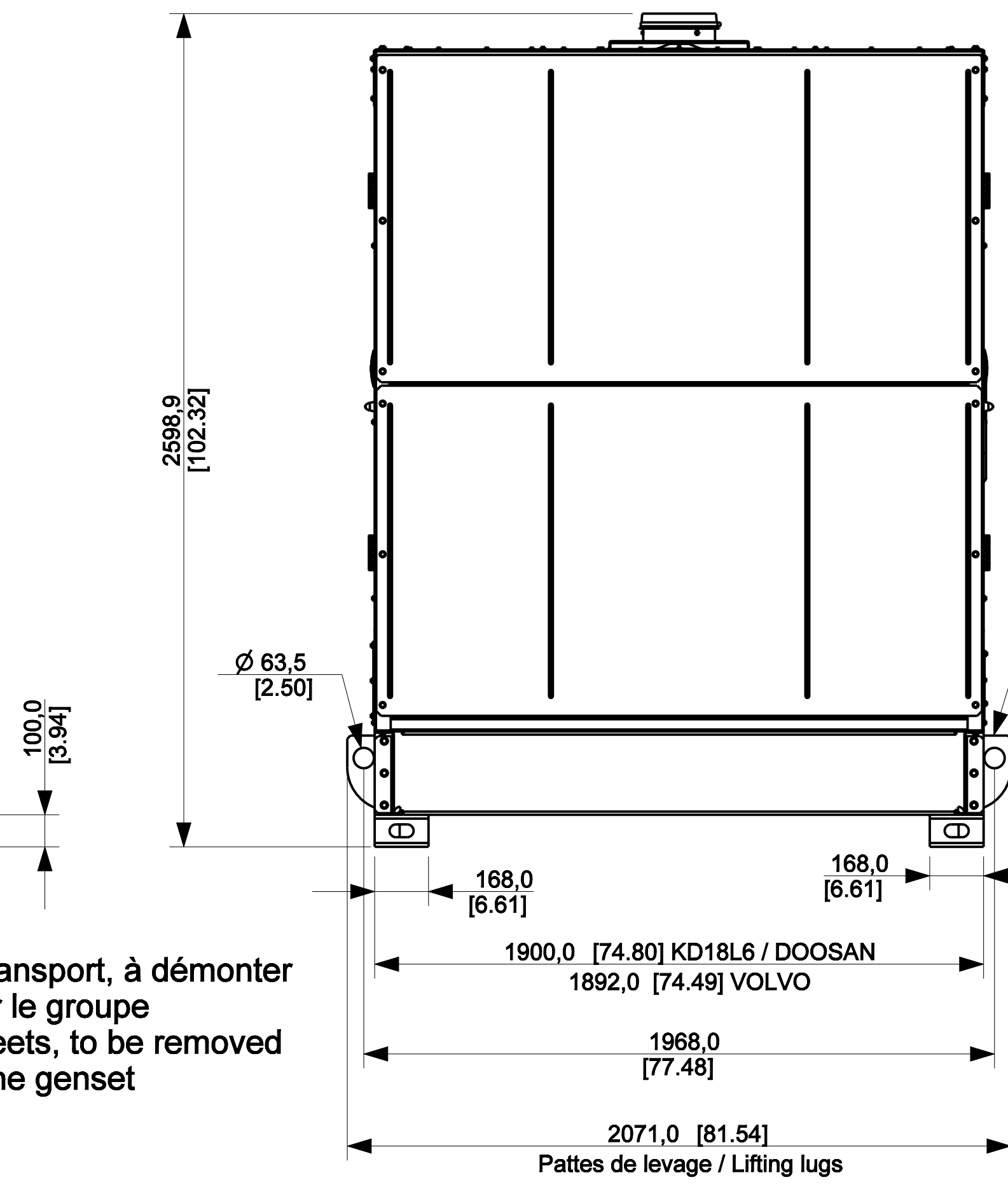
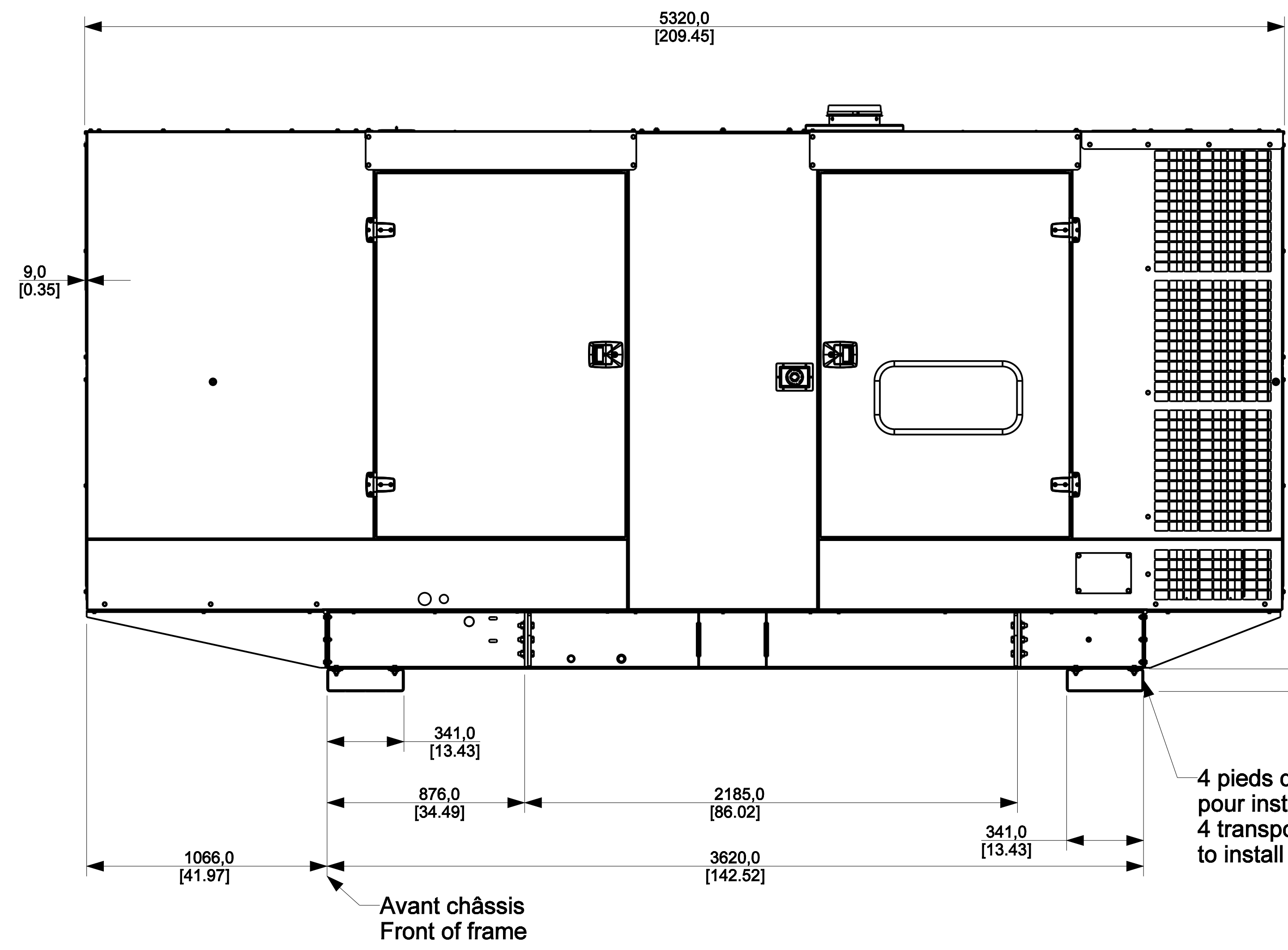

Pattes de levage
Pouvant être démontées
après installation du groupe
Lifting lugs
Can be removed after
installation of the genset

4 pieds de transport, à démonter
pour installer le groupe
4 transport feet, to be removed
to install of the genset

PLAN DE POSE AU SOL / GENSET FOOTPRINT

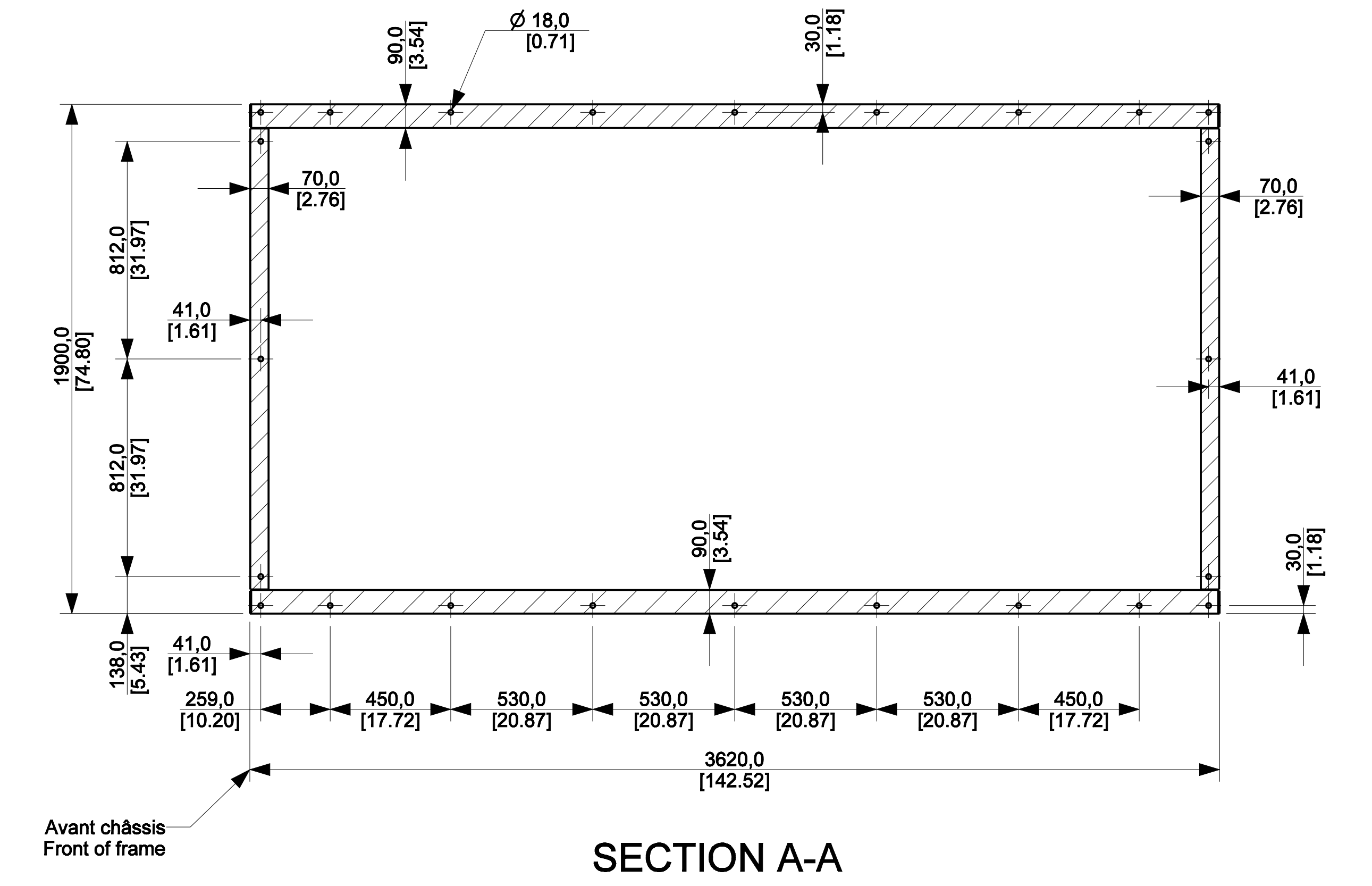

SECTION A-A

VERSION CHASSIS AVEC OU SANS RESERVOIR, AVEC BAC DE RETENTION /
WITH OR WITHOUT TANK FRAME VERSION, WITH RETENTION BUND

DIMENSIONS DE TRANSPORT /
OVERALL DIMENSIONS FOR TRANSPORT

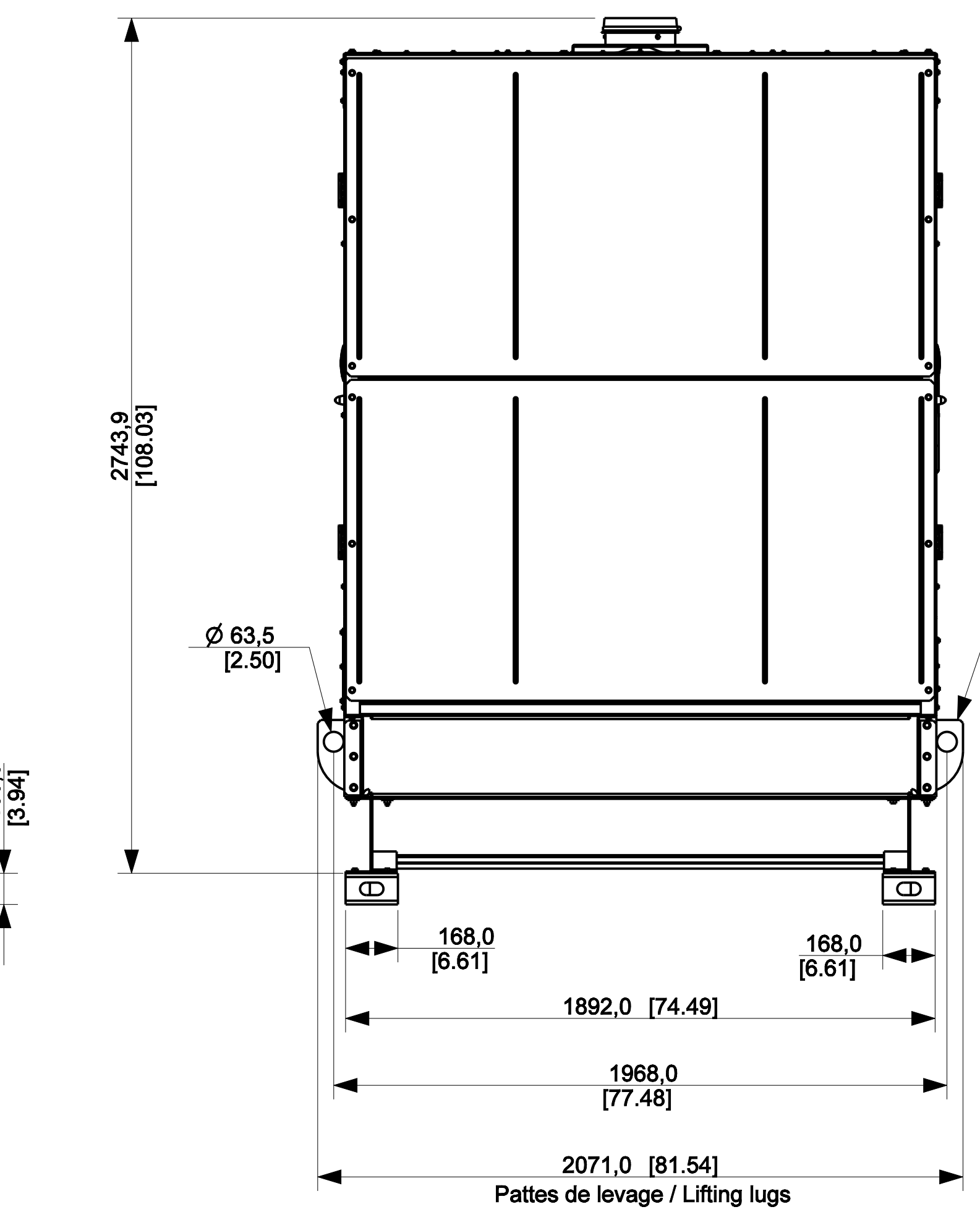
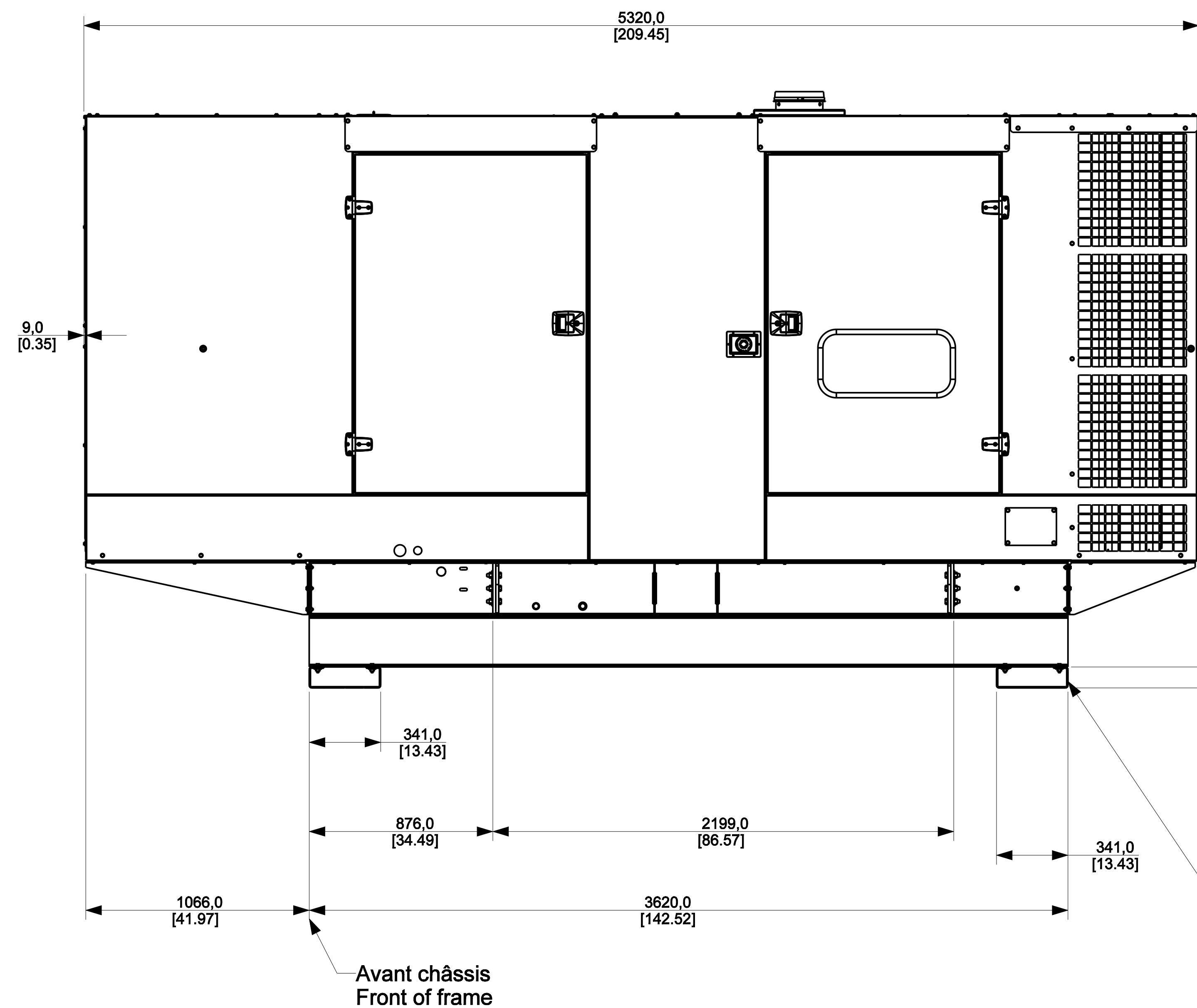

Pattes de levage
Pouvant être démontées
après installation du groupe
Lifting lugs
Can be removed after
installation of the genset

4 pieds de transport, à démonter
pour installer le groupe
4 transport feet, to be removed
to install of the genset

PLAN DE POSE AU SOL / GENSET FOOTPRINT

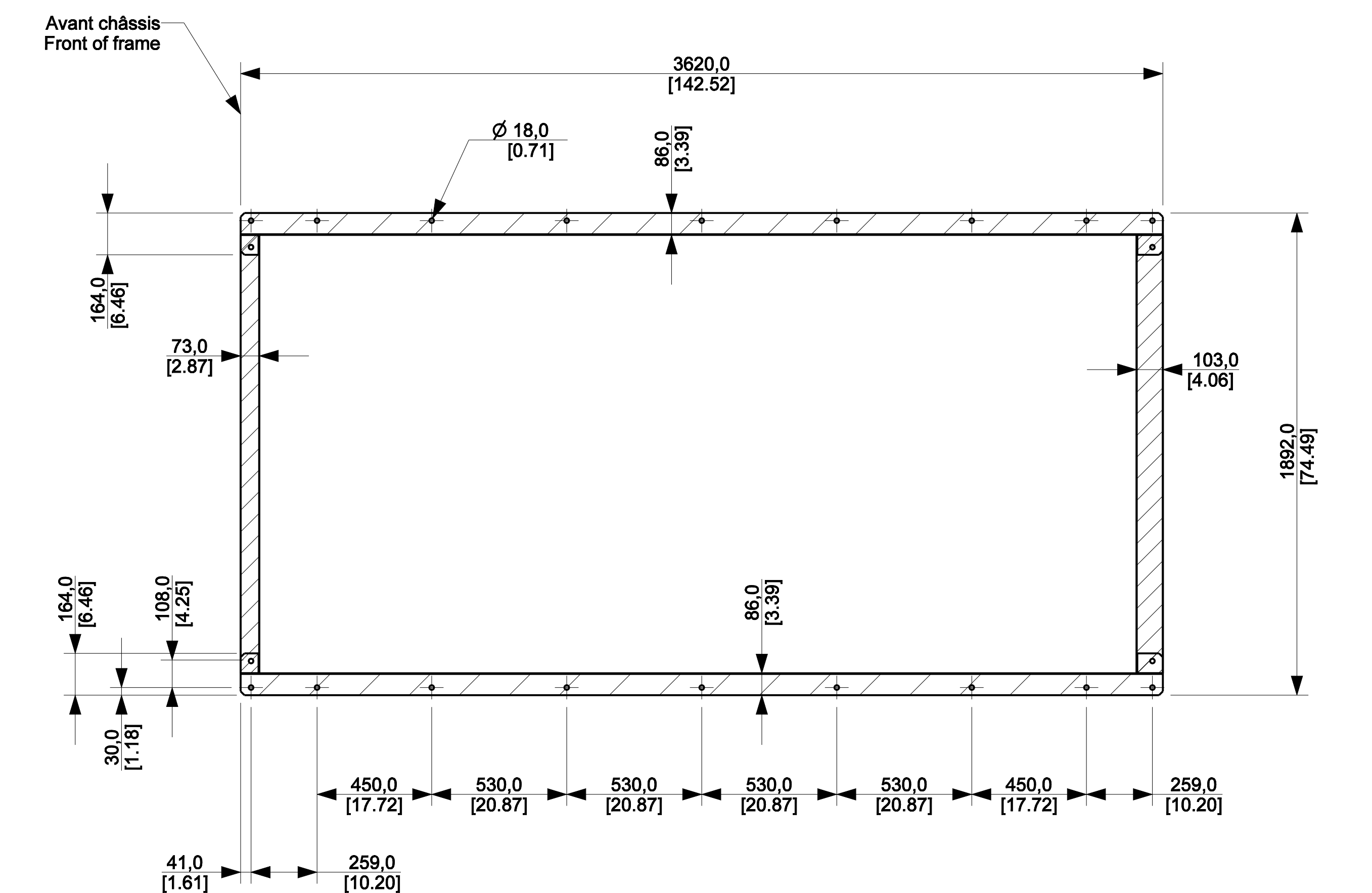

SECTION B-B

REV	DATE	DESCRIPTION	BY	CHK	APP
A	21FEB2023	NEW DRAWING	APM		
B	27SEP2023	DRAWING UPDATED	RBO		
C	28SEP2023	DRAWING UPDATED	SBH		

NO	DATE	DESCRIPTION	BY	CHK	APP
1	21FEB2023	NEW DRAWING	APM		
2	27SEP2023	DRAWING UPDATED	RBO		
3	28SEP2023	DRAWING UPDATED	SBH		

NO	DATE	DESCRIPTION	BY	CHK	APP
1	21FEB2023	NEW DRAWING	APM		
2	27SEP2023	DRAWING UPDATED	RBO		
3	28SEP2023	DRAWING UPDATED	SBH		

NO	DATE	DESCRIPTION	BY	CHK	APP
1	21FEB2023	NEW DRAWING	APM		
2	27SEP2023	DRAWING UPDATED	RBO		
3	28SEP2023	DRAWING UPDATED	SBH		

NO	DATE	DESCRIPTION	BY	CHK	APP
1	21FEB2023	NEW DRAWING	APM		
2	27SEP2023	DRAWING UPDATED	RBO		
3	28SEP2023	DRAWING UPDATED	SBH		

DO NOT SCALE.
THIS ASSEMBLY OR PART MUST
COMPLY WITH THE MODEL FOR
REFERENCE CAD MODEL FOR
UNSPECIFIED DIMENSIONS.

KOHLER

SCALE: 1:15 SHEET SIZE: A0 SHEET: 3 OF 3

PLANT: CP-EX4-M240-FRAME-WWO-TANK
REV. NO. 30001546501